

Siphon for basin 1 1/4" - Brushed Dark Platinum







IMO

10 060 780

• rosette 78 x 78 mm



Fits: IMO, MEM, CL.1, CYO

|   |                                |               |
|---|--------------------------------|---------------|
|    | Brushed Dark Platinum          | 10 060 780-99 |
|    | Chrome                         | 10 060 780-00 |
|    | Brushed Platinum               | 10 060 780-06 |
|    | Platinum                       | 10 060 780-08 |
|    | Dark Chrome                    | 10 060 780-19 |
|    | Brushed Durabronze (23kt Gold) | 10 060 780-28 |
|    | Matte Black                    | 10 060 780-33 |
|    | Brushed Champagne (22kt Gold)  | 10 060 780-46 |
|    | Champagne (22kt Gold)          | 10 060 780-47 |
|  | Brushed Chrome                 | 10 060 780-93 |

# Siphon for basin 1 1/4" - Brushed Dark Platinum

IMO

10 060 780

mm [inches]

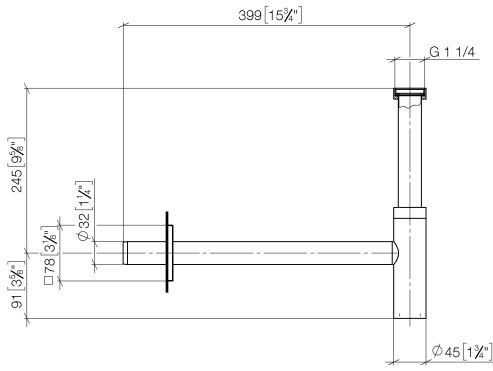

10 060 780

Parts for other finishes can be found here: [Chrome](#)



Spare parts list

| No.  | Item Number        | Name    | Quantity used | Delivery time |
|--|--------------------|---------|---------------|---------------|
| 1  | 09 14 20 060 90    | seal    | 1             | 2             |
| 2  | 09 28 23 007-99    | pipe    | 1             | 30            |
| 3  | 09 23 30 022-99    | nut     | 2             | 30            |
| 4  | 09 14 03 015 90    | seal    | 1             | 2             |
| 5  | 09 28 23 019-99    | pipe    | 1             | -             |
| Spare part can no longer be ordered, please order the replacement item |                    |         |               |               |
| 6  | 09 14 10 149 90    | seal    | 1             | 2             |
| 7  | 04 11 01 045 00-99 | casing  | 1             | 30            |
| 8  | 09 14 10 148 90    | seal    | 2             | 2             |
| 9  | 09 21 02 004-99    | lid     | 1             | 30            |
| 10   | 09 14 10 112 90    | seal    | 2             | 2             |
| 11   | 09 28 23 018-99    | pipe    | 1             | 30            |
| 12   | 09 27 78 021-99    | rosette | 1             | 60            |